

# R3 | MINI-REVEAL

\* Rollformed profiles  
Wall, Soffit Application

Mini-Reveal is a hidden fastener system that can be used in wall & soffit application. With a face size as small as 4"(102mm), it is a perfect alternative to cedar siding with more color selections and minimal maintenance.

- > Variable Width of: 4" (102mm) up to 11.5" (292mm)
- > Cost Efficient Width: 5.1" (130mm), 7.5" (191mm), 11.5"(292mm)
- > Roll-formed to custom lengths in 24ga. & 22ga. steel.
- > Available in: Pre-Painted Steel (Woodgrain, SMP, PVDF)  
(aluminum, copper, rheinzink please inquire.)

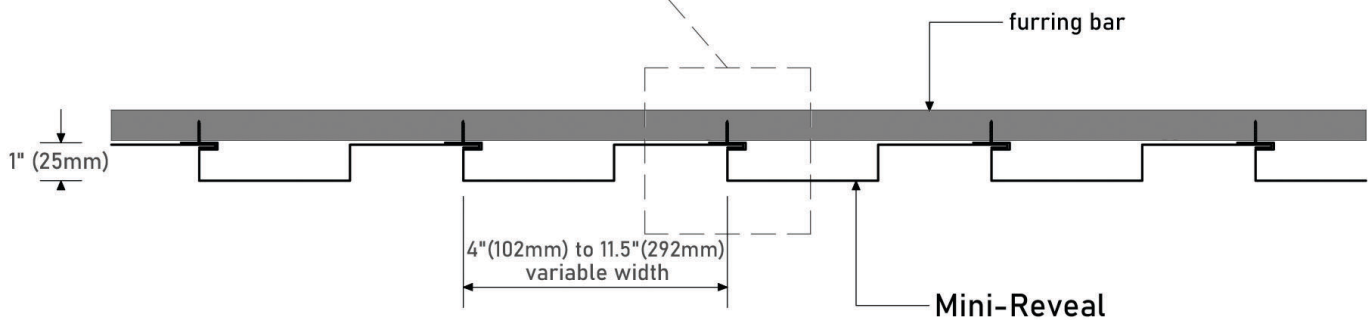
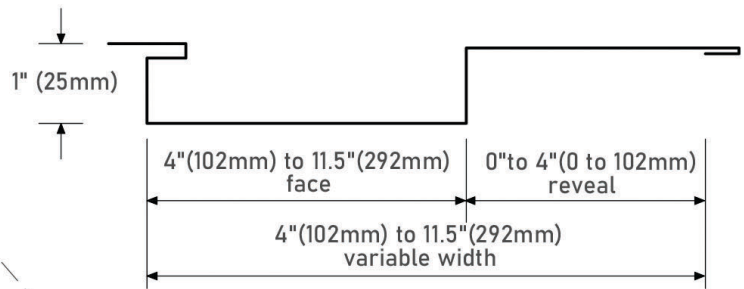
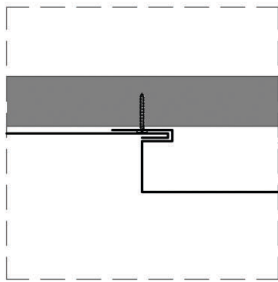
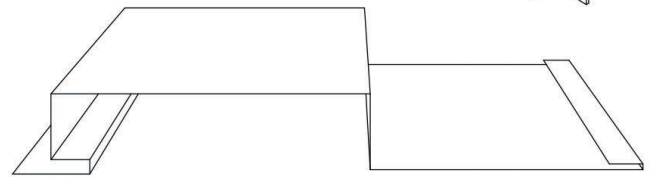
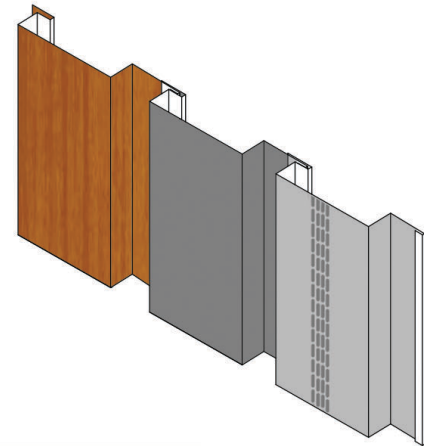

## Panel Layout Examples:

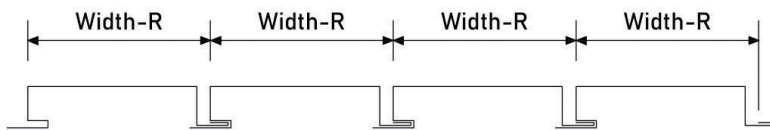

\*Fixed Width panel layout

## Options:

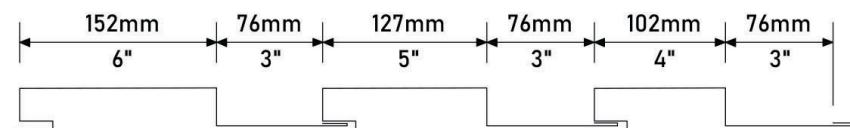

\* Variable Width panel layout



LMC Manufacturing Ltd.

6962 Buller Avenue  
Burnaby, BC  
V5J 4S3

Tel: 604.430.3233  
Website: [www.lammetal.ca](http://www.lammetal.ca)